

# Lastaussiltana toimiva alumiinirakenteinen perälauta

Alumiinirakenteinen perälauta toimii myös lastaussiltana. Sillan ajotaso on joko uritettu tai kohokuvioitu. Tuotevalikoimaan

kuuluu kolme eri versiota, joissa on pianosaranointi 16 mm:n ruostumattomalla akselilla.



## Malli RWB

Kohokuvioitu perälauta

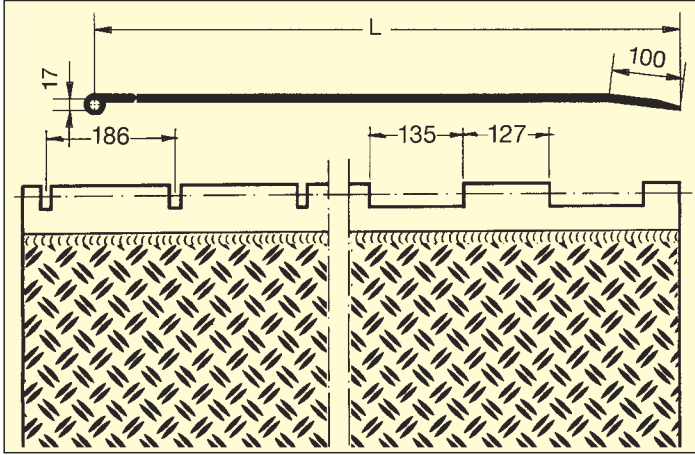

Versio 3:n liitännärakenne

Versioiden 1 ja 2 liitännärakenne

## Liitännöjen rakenne

Versio 1

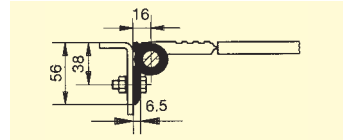

Versio 2

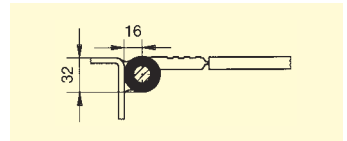

Versio 3

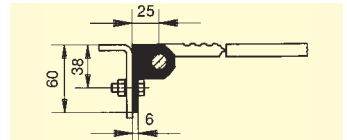

## Malli RPB-30

30 mm:n ontelorakenteinen perälauta

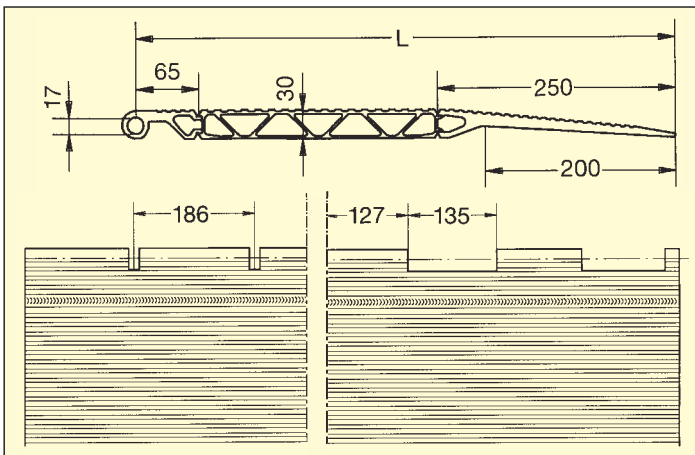

Versio 3:n liitännärakenne

Versioiden 1 ja 2 liitännärakenne

## 30 mm:n reunaprofiili

Tilauksesta perälauta voidaan vahvistaa reunaprofiililla.

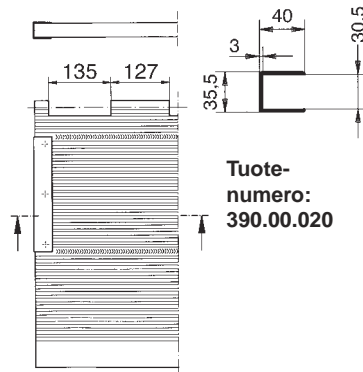

Tuote-  
numero:  
390.00.020

Versio 1

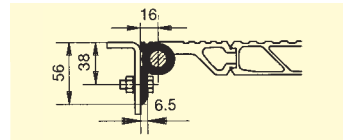

Versio 2

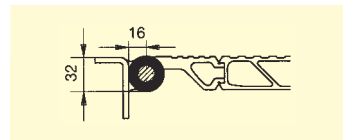

Versio 3

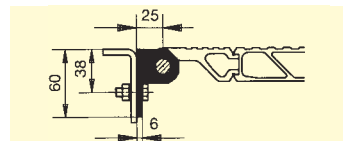

## Malli RPB-40

40 mm:n ontelorakenteinen perälauta

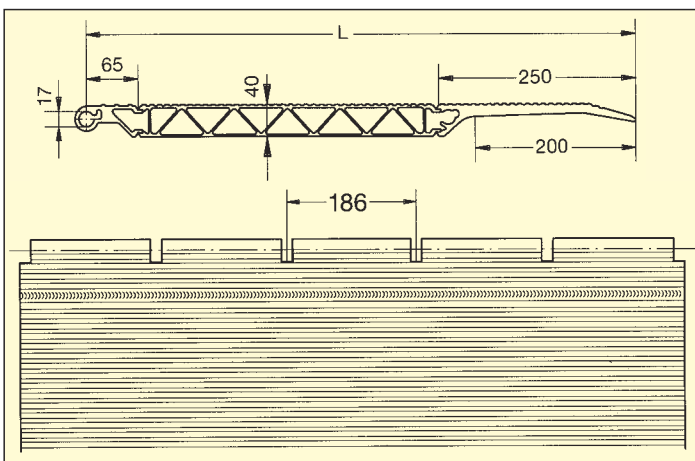

## 40 mm:n perälaudan reunaprofiili

Tilauksesta perälauta voidaan vahvistaa reunaprofiililla.

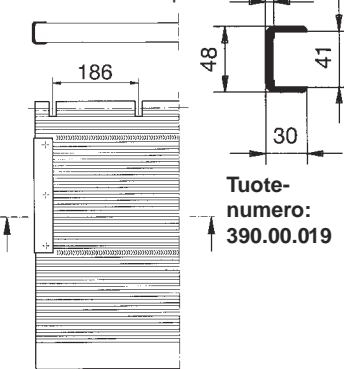

Tuote-  
numero:  
390.00.019

Versio 3

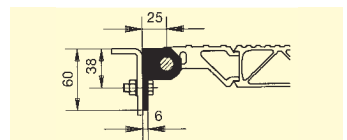

# Perälaudan liitännärakenteet

## Versio 1

Alumiinirakenteinen kiinni ruuvattava versio

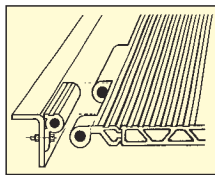

## Versio 2

Kiinni hitsattava teräsholkkirakenne

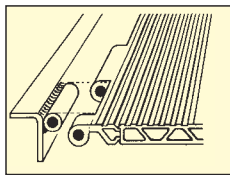

## Versio 3

(System ALTEC)

Hitsaamalla tai ruuvamalla kiinnitettävä koko leveyden mittainen terässarana

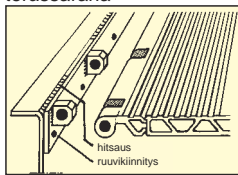

Tuotenumero Versio 1	Tuotenumero Versio 2	Tuotenumero Versio 3	Pituus (L) mm	Leveys (B) mm	Kantavuus (kp)	Oma paino kg
391.31.000	391.32.000	391.30.000	600	2300	2500	40
391.31.001	391.32.001	391.30.001	600	2500	2500	44
391.31.002	391.32.002	391.30.002	800	2300	1900	53
391.31.003	391.32.003	391.30.003	800	2500	1900	58
391.31.004	391.32.004	391.30.004	900	2300	1700	59
391.31.005	391.32.005	391.30.005	900	2500	1700	65
391.31.006	391.32.006	391.30.006	1000	2300	1500	66
391.31.007	391.32.007	391.30.007	1000	2500	1500	72

Tuotenumero Versio 1	Tuotenumero Versio 2	Tuotenumero Versio 3	Pituus (L) mm	Leveys (B) mm	Kantavuus (kp)	Oma paino kg
390.31.000	390.32.000	390.30.000	565	Leveys asiakkaan toivomuksen mukaan	3500	16
390.31.001	390.32.001	390.30.001	690		3000	19
390.31.002	390.32.002	390.30.002	815		2500	22
390.31.003	390.32.003	390.30.003	940		2300	26
390.31.004	390.32.004	390.30.004	1065		2100	29
390.31.005	390.32.005	390.30.005	1190		1900	32
390.31.006	390.32.006	390.30.006	1315		1600	35
390.31.007	390.32.007	390.30.007	1565		1300	42
390.31.008	390.32.008	390.30.008	1690		1100	45
390.31.009	390.32.009	390.30.009	1815		900	48
390.31.010	390.32.010	390.30.010	2065	700	54	

		Tuotenumero Versio 3	Pituus (L) mm	Leveys (B) mm	Kantavuus (kp)	Oma paino kg
		392.30.000	565	Leveys asiakkaan toivomuksen mukaan	4500	21
		392.30.001	690		4000	23
		392.30.002	815		3500	27
		392.30.003	940		3000	31
		392.30.004	1065		2800	33
		392.30.005	1190		2600	37
		392.30.006	1315		2500	41
		392.30.007	1565		2400	47
		392.30.008	1690		2100	51
		392.30.009	1815		1800	53
		392.30.010	2065	1400	60	